

# HVAC & Enclosure Sealing Solutions

Engineered by Huge Believe

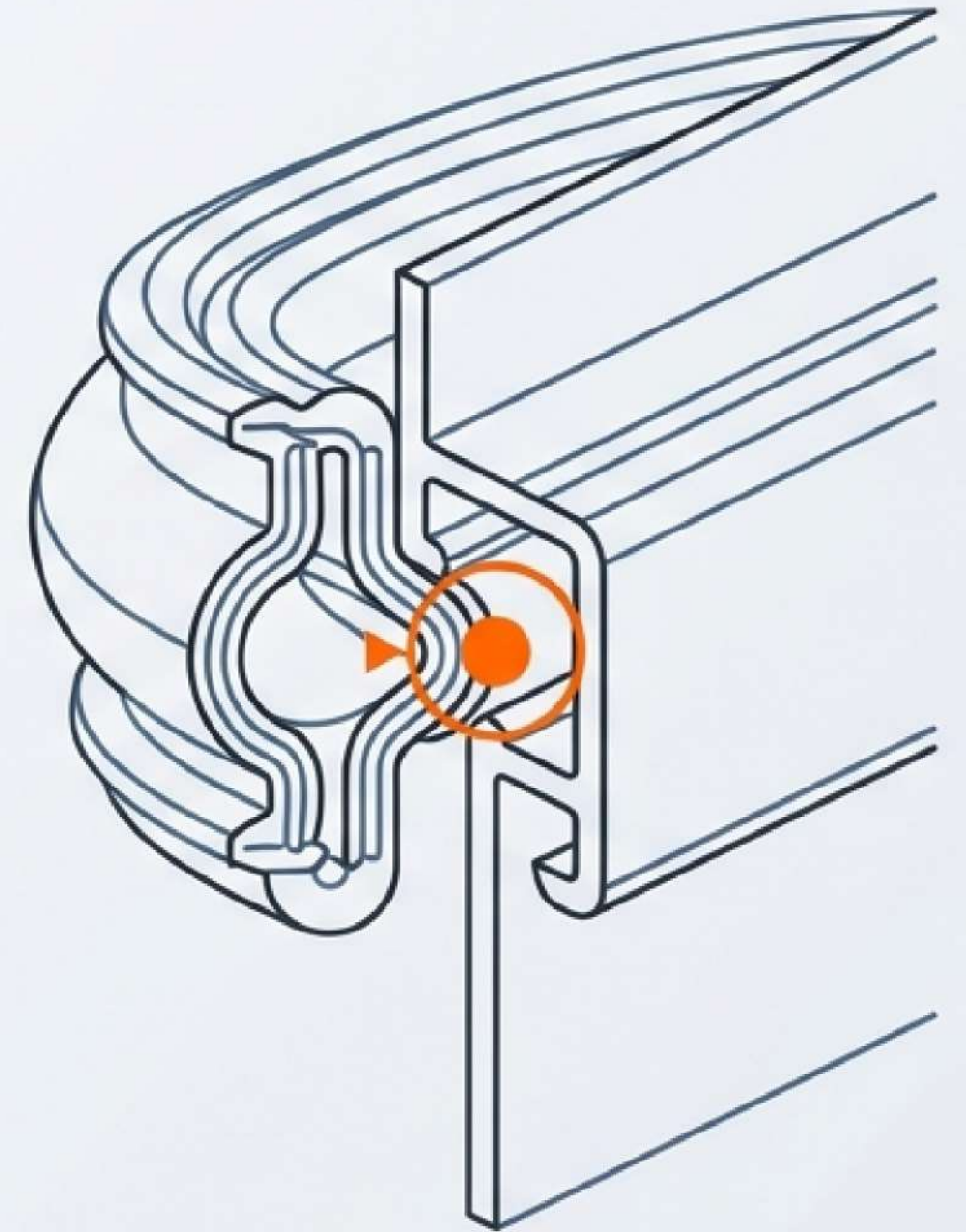

# Manufacturing Excellence



Brand

**Huge Believe**



Origin

**India**



Established

**2019**



Quality Standard

**ISO 9001 Certified**

# Engineered Sealing Profiles

**1**



**Edge Trim +  
Bulb Seals  
(Self-Grip)**

**2**

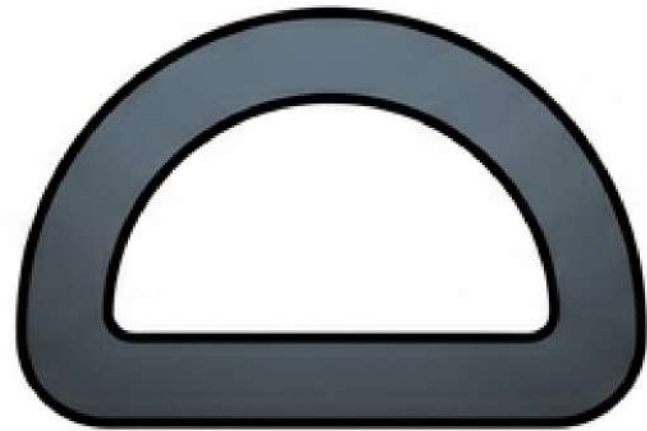

**Sponge D-Seal  
(PSA Backed)**

**3**

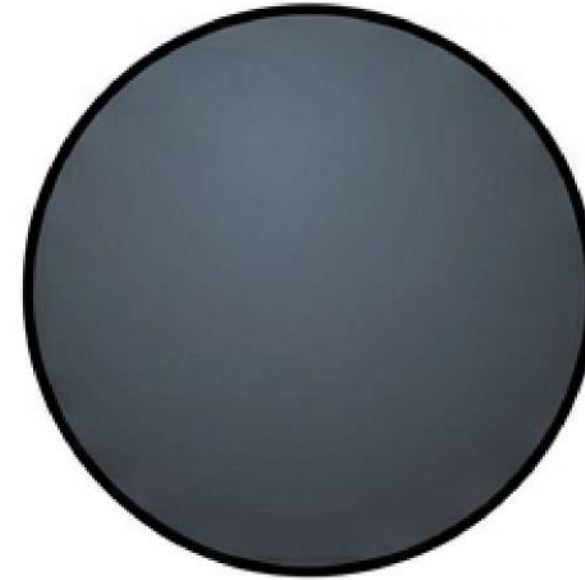

**Sponge Cord  
(Closed-Cell)**

**4**







**Flat Strip  
(Compression  
Seal)**

# Edge Trim and Bulb Seals

Self-gripping profile with a compressible bulb designed for vibration resistance and dust control.

## Key Applications

-  AHU / FCU access doors
-  Control panels & electrical enclosures
-  Filter access doors
-  Rooftop units (Outdoor variants)

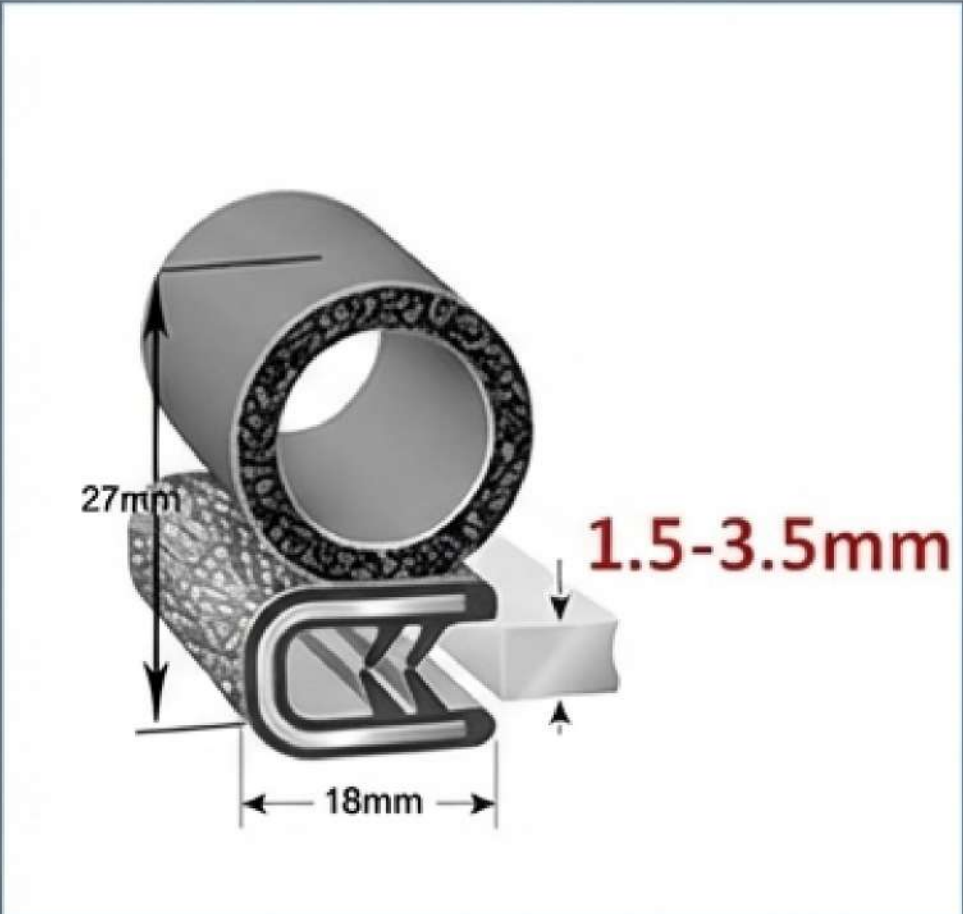
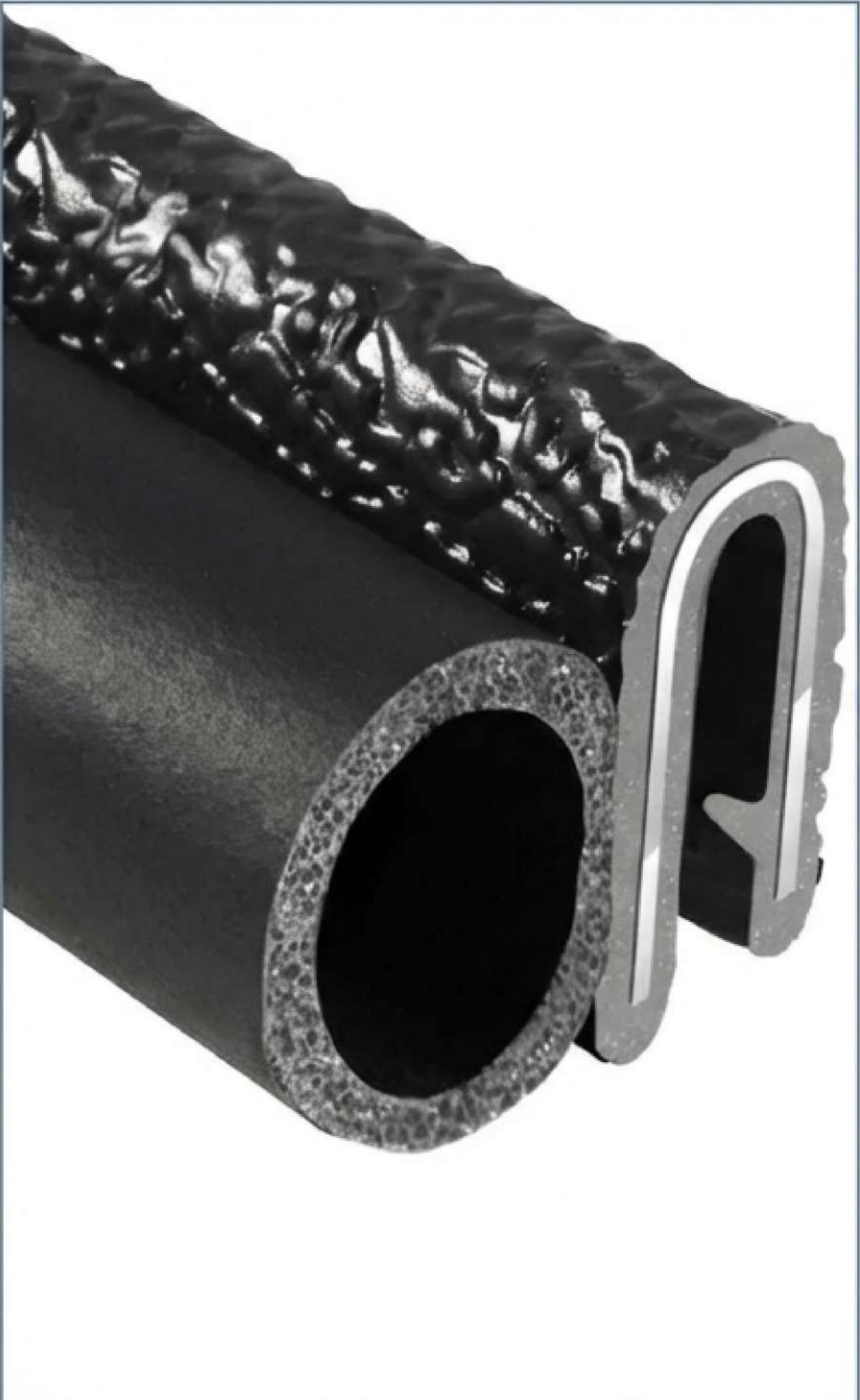

# Edge Trim Specifications

Stock SKUs

Immediate Availability ↗

**SKU HB-ETB-08-15-B10**

 0.8–1.5 mm Grip

 ~10 mm Bulb

 EPDM bulb + reinforced trim

 Up to 90°C

 Thin sheet doors

 25m roll / cut

**SKU HB-ETB-15-30-B10**

 1.5–3.0 mm Grip

 ~10 mm Bulb

 EPDM bulb + reinforced trim

 Up to 90°C

 Standard AHU doors

 25m roll / cut

**SKU HB-ETB-25-40-B14**

 2.5–4.0 mm Grip

 ~14 mm Bulb

 EPDM bulb (heavy duty)

 Up to 100°C

 Uneven / outdoor frames

 25m roll / cut

Quote-Only Variants

Custom Order Status

**B18 Option**

 0.8–4.0 mm Grip

 ~18 mm Bulb

 Use Case: Retrofit uneven gaps

**B20 Option**

 0.8–4.0 mm Grip

 ~20 mm Bulb

 Use Case: Extreme compression gaps

**40–60 Grip**

 4–6 mm Grip

 B14 / B18 Bulb

 Use Case: Thick hemmed panels

# Sponge D-Seal Solutions

Closed-cell EPDM sponge D-profile with pressure-sensitive adhesive backing for quick retrofit installation.



## Key Applications



Quick sealing retrofit



Access door gap correction



Maintenance & MRO usage

Stock SKU

## HB-DS-15x10-PSA



15 x 10 mm



Material



Acrylic PSA



Up to 80°C

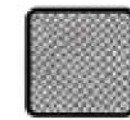

Medium Density



10m roll

## Quote-Only Variants



HB-DS-10x8-PSA



10 x 8 mm

STD / HT / HI-TACK options



HB-DS-20x12-PSA



20 x 12 mm



STD / HT / HI-TACK options

# Closed-Cell Sponge Cords

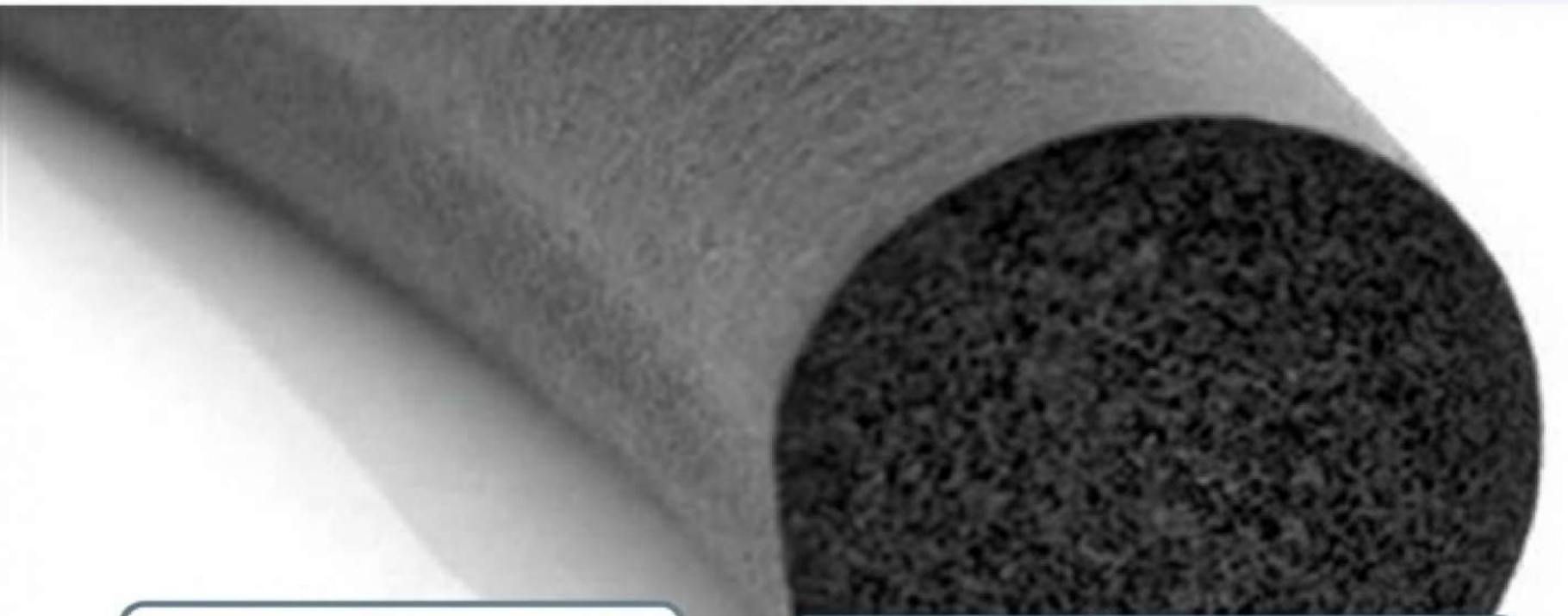
Round closed-cell sponge cord designed for irregular gaps and channel insert applications.



## Key Applications

-  Uneven retrofit gaps
-  Door frame stuffing
-  Channel-retained seals

## Stock SKU

### HB-SC-08

 **8 mm Diameter**

 **Material**

 **Medium Density**

 **Up to 80°C**

 **Medium Density**

 **20–25m coil**

## Quote-Only Extensions

 **HB-SC-06**

 **6 mm**

 **Soft / Firm**

 **HB-SC-10**

 **10 mm**

 **Soft / Firm**

 **HB-SC-12**

 **12 mm**



 **Soft / Firm**

# Flat Strip Compression Seals

Flat EPDM strip utilized for uniform compression sealing on filter frames and flat surfaces.

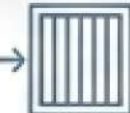

## Key Applications

-  Filter frame sealing
-  Flat compression gaskets
-  Panel sealing

## Stock SKU

# HB-FS-3x25



3 mm Thickness



25 mm Width



EPDM Material



10-25m roll

## Quote-Only Extensions



HB-FS-3x20

3 x 20 mm

PSA optional



HB-FS-3x30

3 x 30 mm

PSA optional



HB-FS-3x25-PSA

3 x 25 mm

STD / HT  
adhesive options

# Global Packaging and Export Format

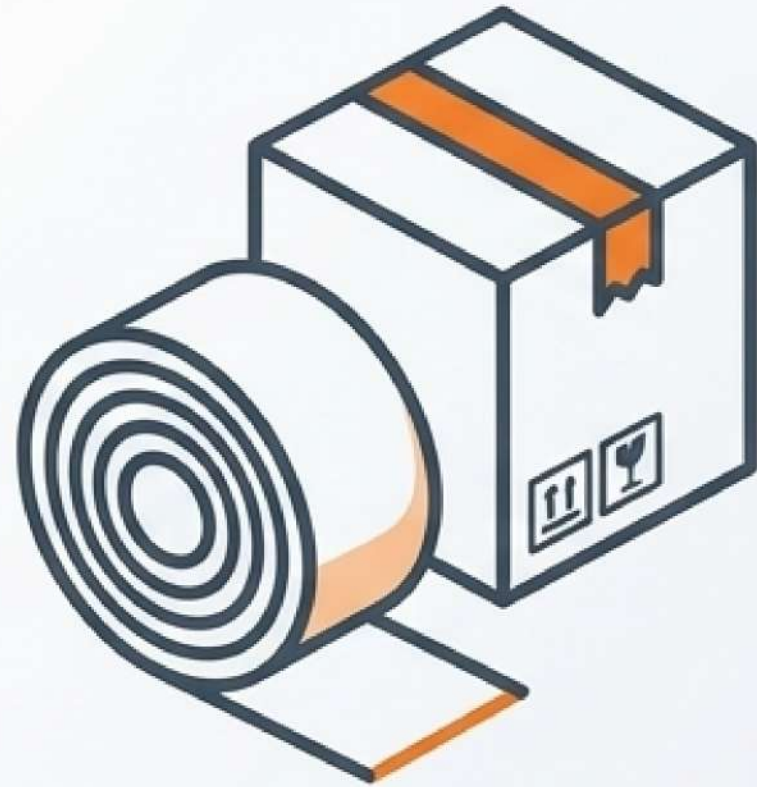

## Standard Rolls

Shipped in 10m and 25m standard lengths.

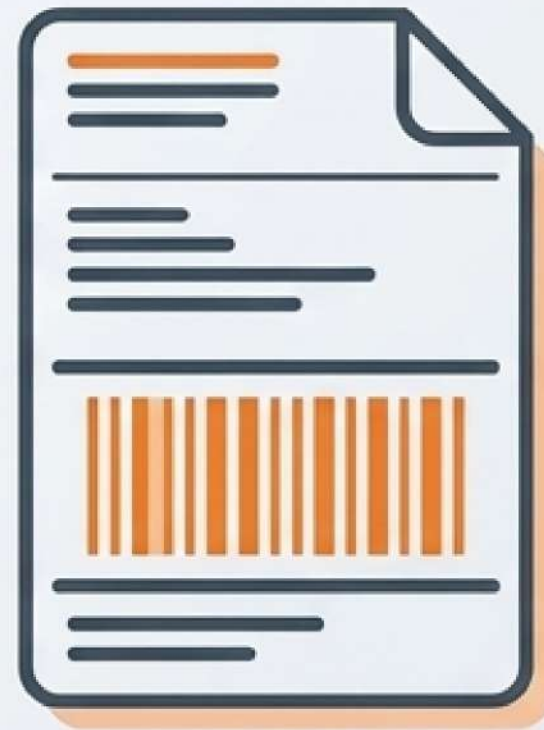

## Labeling Precision

Every package is marked with SKU, precise size, and batch number for inventory tracking.



## Export Classification

Indicative HS Codes fall under the 401693 / 4008 family (final classification subject to product selection).

# Streamlined Procurement for Industrial HVAC

Uniting off-the-shelf stock readiness with custom engineering flexibility for dynamic HVAC and enclosure applications.

---

Reach out to the Huge Believe manufacturing team to initiate standard roll orders or to specify quote-only variants for specialized sealing environments.

## Contact Us

 +91-9029789313       [bishal@hugebelieve.com](mailto:bishal@hugebelieve.com)

 Address: Hanuman Colony, Ulhasnagar, Mumbai, India.

**Huge Believe**

